



ikio
LED LIGHTING

LED

HIGH BAYS

High-Performing High Bay Lights to Brighten Up Large Spaces With High Ceilings!

www.ikioledlighting.com

IKIO: A Disruptive LED Lighting Solutions Company

IKIO is one of the fastest growing LED lighting brands that has built a successful track record of being a reliable and trusted LED lighting partner. We at IKIO combine innovative ideas, expertise & advanced technology to create cutting-edge lighting solutions that are changing the landscape of the industry. Moreover, we are ideally positioned to offer the right solutions for all your lighting requirements because of our holistic approach and vertically integrated infrastructure.

Why Choose **IKIO?**



One-stop destination

Offering complete lighting solutions for application in Commercial, Industrial, Educational, Sports, Retail and Hazardous locations.



Constant research & design

We constantly research to develop new and groundbreaking lighting solutions.



In-house manufacturing units

We have 6 state-of-the art manufacturing units across different countries that are capable of manufacturing approximately 10 million LED lighting fixtures annually.



Proactive client servicing

We strive to serve our customers to their utmost satisfaction through our dedicated service portals.

LED High Bays

An Ideal Combination of Smart
Technology, Sturdy Body &
Seamless Design!

High bay lights are a must-have in large, high ceiling warehouses, airports, manufacturing units, or aircraft hangers to allow even illumination of the space for proper visibility. However, to achieve the desired results, you must invest in lights that have undergone rigorous testing and have the ability to pass the test of time.

Interestingly, IKIO's range of high bay lights has acquired all the major quality certifications and holds the ability to last for several years without requiring you to spend much on their maintenance.

Exceptional efficacy, superior heat dissipation, high IP rating, and multiple lumen packages are some of the features that make IKIO's LED highbay lights a better choice over others.

Types of High Bays

High bay lights are offered in two different shapes depending on the height of the application area and amount of light required to perfectly illuminate the space.



1
Linear
High Bays

2
UFO
High Bays

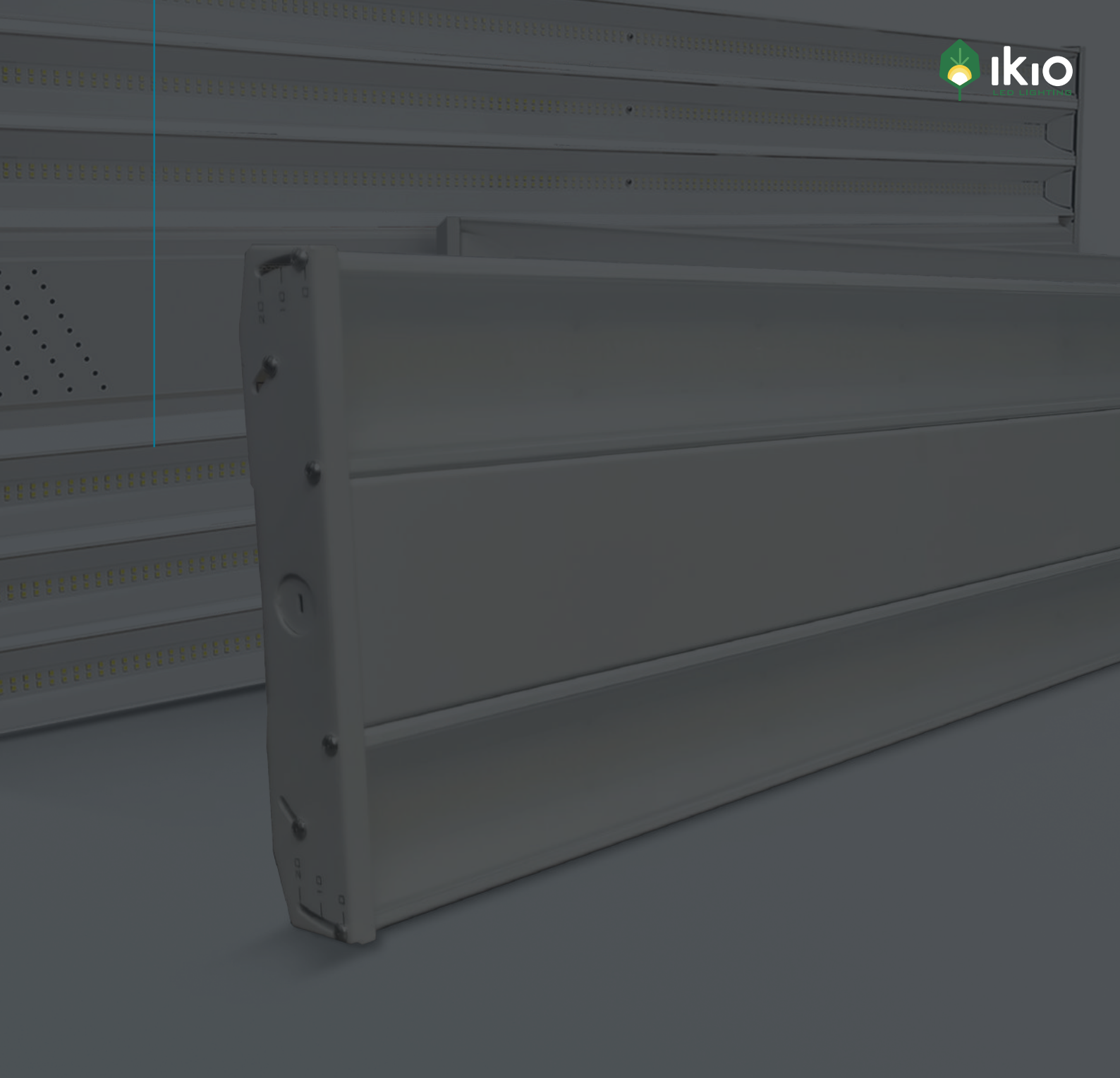

Linear High Bays

Linear High Bays, also called panel-style high bays, are rectangular in shape which results in a rectangular beam light distribution. These luminaires are an ideal replacement for the traditional T5 and T8 lights. Linear high bays are helpful in covering long workbenches and aisles and are commonly used in education facilities, cafeterias, recreation centers, and airports.

Our Offerings

We offer a range of LED luminaires under the Linear High Bays.





Amplin

LINEAR HIGH BAY 1'x2' | 1'x4'

Electrical

Power	75 W 100 W 150 W 200 W 240 W 300 W 400 W
Voltage	100-277 V (Also 277-480 V, 346-480 V fixtures available)
Power Factor	0.9988

Lighting Performance

Lumens	11250 lm 15000 lm 22500 lm 30000 lm 36000 lm 45000 lm 60000 lm
Efficacy	150 lm/W
Color Temperature (CCT)	4000 K 5000 K
Color Rendering (CRI)	80+
Beam Angle	120°
Light Distribution	Type VS
Dimmable Lighting Control	0-10 V, Range 10% - 100%

Environment

Operating Temperature	-10 °F ~ +120 °F
Suitable Location	DAMP
Ingress Protection Rating (IP)	IP54

Lifespan

Average Life (Hours)	75,000
Warranty (Years)	7

Components

LED Light Source	Bridgelux 2835
Driver	Meanwell

Construction

Housing	C.R.S. Powder Coated
Heat Sink	Aluminum
Base / Power Supply	Hard Wire
Diffuser	Polycarbonate
Finish	White

Application Areas

Arenas, Gymnasiums, Plazas, Airports, Courtyards, Retail Spaces.

Qualifications and Certifications

Qualified Part Number	IK-HBAX
-----------------------	----------------



DesignLights Consortium® (DLC) Premium qualified product. Not all versions of this product may be DLC qualified. Please check the DLC Qualified Products List at www.designlights.org/QPL to confirm which versions are qualified.

*Specifications, Warranty, and Qualifications can vary per item/SKU. See technical data sheets (TDS) for specific information.

Note: Power options available

- 1'x2' = 75 W | 100 W | 150 W • 1'x4' = 200 W | 240 W | 300 W | 400 W

Dimensions and Weight

75 W - 100 W - 150 W

Length	22.8"
Width	9.52"
Height	1.8
Net Weight (lbs)	7.87
Chain Length	30.3
Wire Length	30.3

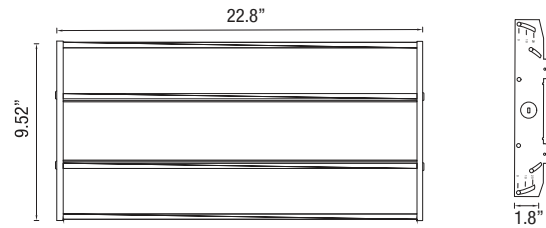

200 W - 240 W - 300 W - 400 W

Length	43.1"
Width	9.85"
Height	1.8
Net Weight (lbs)	15.2
Chain Length	30.3
Wire Length	30.3

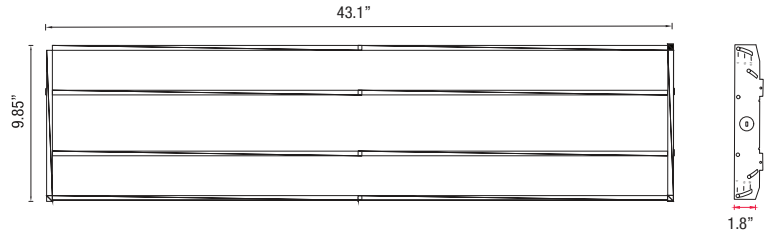

Installation Instructions

Important Safeguards

PLEASE FIND A QUALIFIED ELECTRICIAN FOR INSTALLATION. PLEASE READ THE INSTRUCTIONS BEFORE YOU INSTALL AND USE THE LUMINAIRE. WARNING, CAUTIONS AND OPERATING INSTRUCTIONS

- To reduce the risk of death, personal injury or property damage from fire, electric shock, falling parts, cuts/abrasions, and other hazards, read all warnings and instructions included with and on the fixture box and all fixture labels.
- Before installing, servicing, or performing routine maintenance upon this equipment, follow these general precautions.
- Commercial installation, service and maintenance of luminaires should be performed by a qualified licensed electrician.
- For the installation: If you are unsure about the installation or maintenance of the luminaires, consult a qualified licensed electrician and check your local electrical code.
- To prevent wiring damage or abrasion, do not expose wiring to edges of sheet metal or other sharp objects.
- Do not make or alter any open holes in an enclosure of wiring or electrical components during kit installation.

WARNING: RISK OF FIRE OR ELECTRICAL SHOCK

- Turn off electrical power at fuse or circuit breaker box before wiring fixture to the power supply.
- Turn off the power when you perform any maintenance.
- Verify that supply voltage is correct by comparing it with the luminaire label information.
- Make all electrical and grounded connections in accordance with the National Electrical Code and any applicable local code requirements.
- All wiring connections should be capped with UL approved wire connectors.
- Do not make or alter any open holes in an enclosure of wiring or electrical components during kit installation.

⚠ WARNING: DISCONNECT POWER BEFORE INSTALLING OR SERVICING.

Installation and Electrical Connection

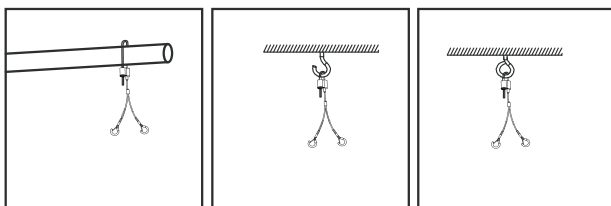

1. Hang the suspension rope through the ring, hook or rod.

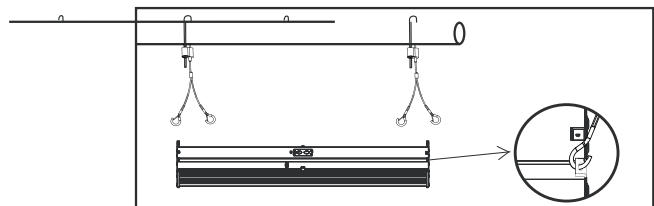

2. Hook the spring buckle on the suspension rope to the installation hole of the lamp

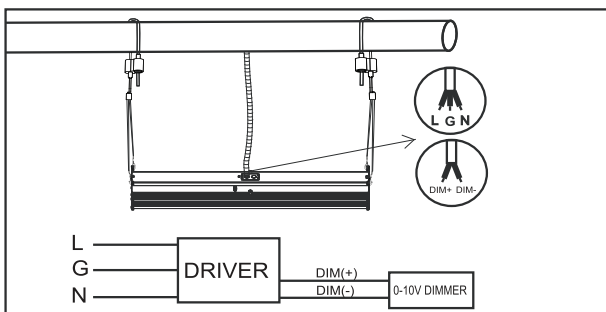

3. Please connect all cables and terminals according to the wiring diagram. Please pay attention to the grounding.

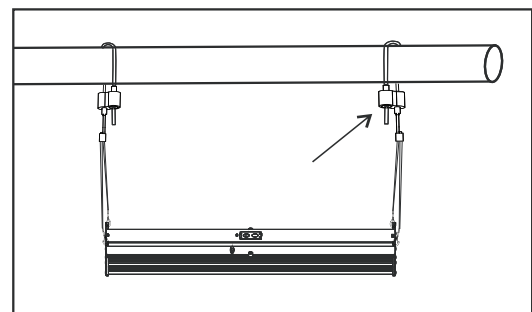

4. Adjust the suspension rope to keep the lamp tidy and balanced.

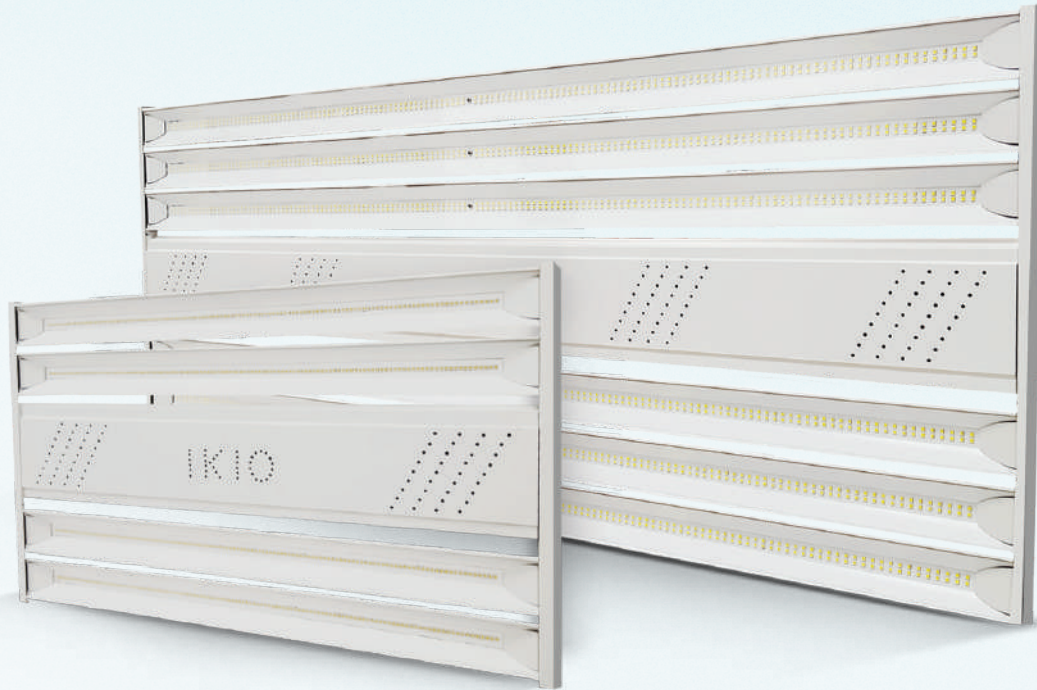

Superia

LINEAR HIGH BAY

Electrical

Power	60 W 100 W 200 W
Voltage	100-277 V
Power Factor	≥ 0.90

Lighting Performance

Lumens	12000 lm 20000 lm 40000 lm
Efficacy	200 lm/W
Color Temperature (CCT)	5000 K
Color Rendering (CRI)	80+
Beam Angle	120°
Light Distribution	Type VS
Dimmable Lighting Control	0-10 V, Range 10% - 100%

Environment

Operating Temperature	-10 °F ~ +120 °F
Suitable Location	DAMP
Ingress Protection Rating (IP)	IP40

Lifespan

Average Life (Hours)	100,000
Warranty (Years)	10

Components

LED Light Source	Edison Opto 2835
Driver	Meanwell

Construction

Housing	Aluminum
Lens	Polycarbonate
Base / Power Supply	Hard Wire
Finish	White
Diffuser	Polycarbonate (Clear Frosted Options)

Application Areas

Large Warehouses, Retail Applications, Commercial Buildings, Work Areas.

Qualifications and Certifications

Qualified Part Number	IK-HBPX-L200
-----------------------	---------------------



DesignLights Consortium® (DLC) Premium qualified product. Not all versions of this product may be DLC qualified. Please check the DLC Qualified Products List at www.designlights.org/QPL to confirm which versions are qualified.

*Specifications, Warranty, and Qualifications can vary per item/SKU. See technical data sheets (TDS) for specific information.

Dimensions and Weight

60 W

Length	23.1"
Height	2.29"
Width	14.1"
Net Weight (lbs)	7.38
Chain Length	30.3
Wire Length	30.3

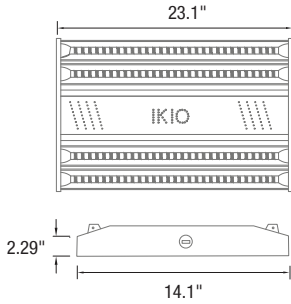

100 W

Length	23.1"
Height	2.29"
Width	14.1"
Net Weight (lbs)	9.811
Chain Length	30.3
Wire Length	30.3

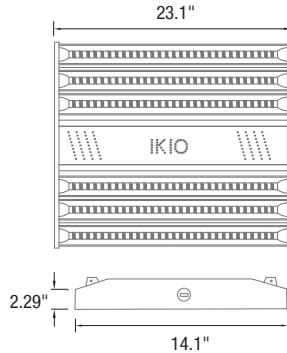

200 W

Length	43.13"
Height	2.29"
Width	19"
Net Weight (lbs)	14.82
Chain Length	30.3
Wire Length	30.3

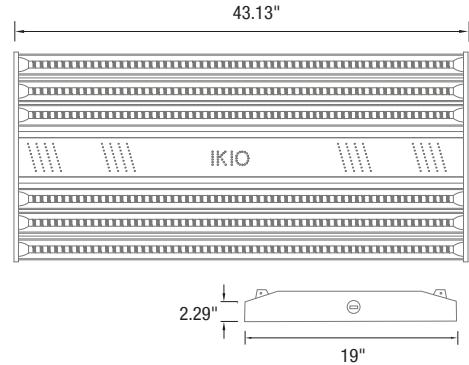

Installation Instructions

Important Safeguards

WHEN USING ELECTRICAL EQUIPMENT, BASIC SAFETY PRECAUTIONS SHOULD ALWAYS BE OBSERVED INCLUDING THE FOLLOWING: READ AND FOLLOW ALL SAFETY INSTRUCTIONS.

- DANGER- Risk of shock- Disconnect power before installation.
- This product must be installed in accordance with the applicable installation code by a person familiar with the construction and operation of the product and the hazards involved.
- Min. 60 °C supply conductors.
- Suitable for damp locations.
- Suitable for wet locations.

⚠ WARNING: DISCONNECT POWER BEFORE INSTALLING OR SERVICING.

Hook And Chain Mount

1. Remove back cover from fixture by unscrewing (4) screws holding cover in place. See Figure 1.
2. Remove desired 1/2" knockout on back cover to allow for cord entry.
3. Insert power supply cord through removed 1/2" knockout and snap strain relief into knockout. Longer section of cord should be on outside of cover.
4. Splice black cord lead to black driver lead, white cord lead to white driver lead, and cord ground lead (green) to fixture ground (green) lead. If 0-10 V dimming is to be used, splice positive dimming supply lead to violet driver lead and negative dimming supply lead to grey driver lead.
NOTE: For dimming connections, use Class 1 wiring methods only.
5. Replace back cover on fixture using (4) screws that were removed in Step 1.
6. Pass the (2) supplied wire hangers through the last links of (2) supplied suspension chains.
7. Install the wire hangers into the back of the fixture. Ends of wire hangers are first inserted into the longer oval holes in the fixture and are then returned out of the fixture through the smaller oval holes. See Figure 1.

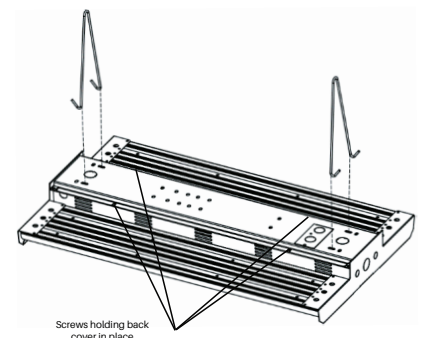

Figure 1

Electrical Connections

Fixture is equipped with universal volt driver 120 - 277 V (ie. 120 V, 208 V, 240 V or 277 V)

Phase To Neutral Wiring 120/277 V

1. Connect supply ground to fixture ground (green) lead.
2. Connect supply common to fixture neutral (white) lead.
3. Connect supply Vin to fixture hot (black) lead.

Tuck all wires carefully into wiring chamber ensuring that no wires are pinched.

Phase To Neutral Wiring 208/240 V

1. Connect supply ground to fixture ground (green) lead.
2. Connect supply L1 (Hot) to fixture neutral (white) lead.
3. Connect supply L2 (Hot) to fixture hot (black) lead.

Tuck all wires carefully into wiring chamber ensuring that no wires are pinched.

Dimming

1. Grey (-) and violet (+) leads are for 0-10 V dimming systems. Cap off if not used.

NOTE: For dimming connections, use Class 1 wiring methods only.

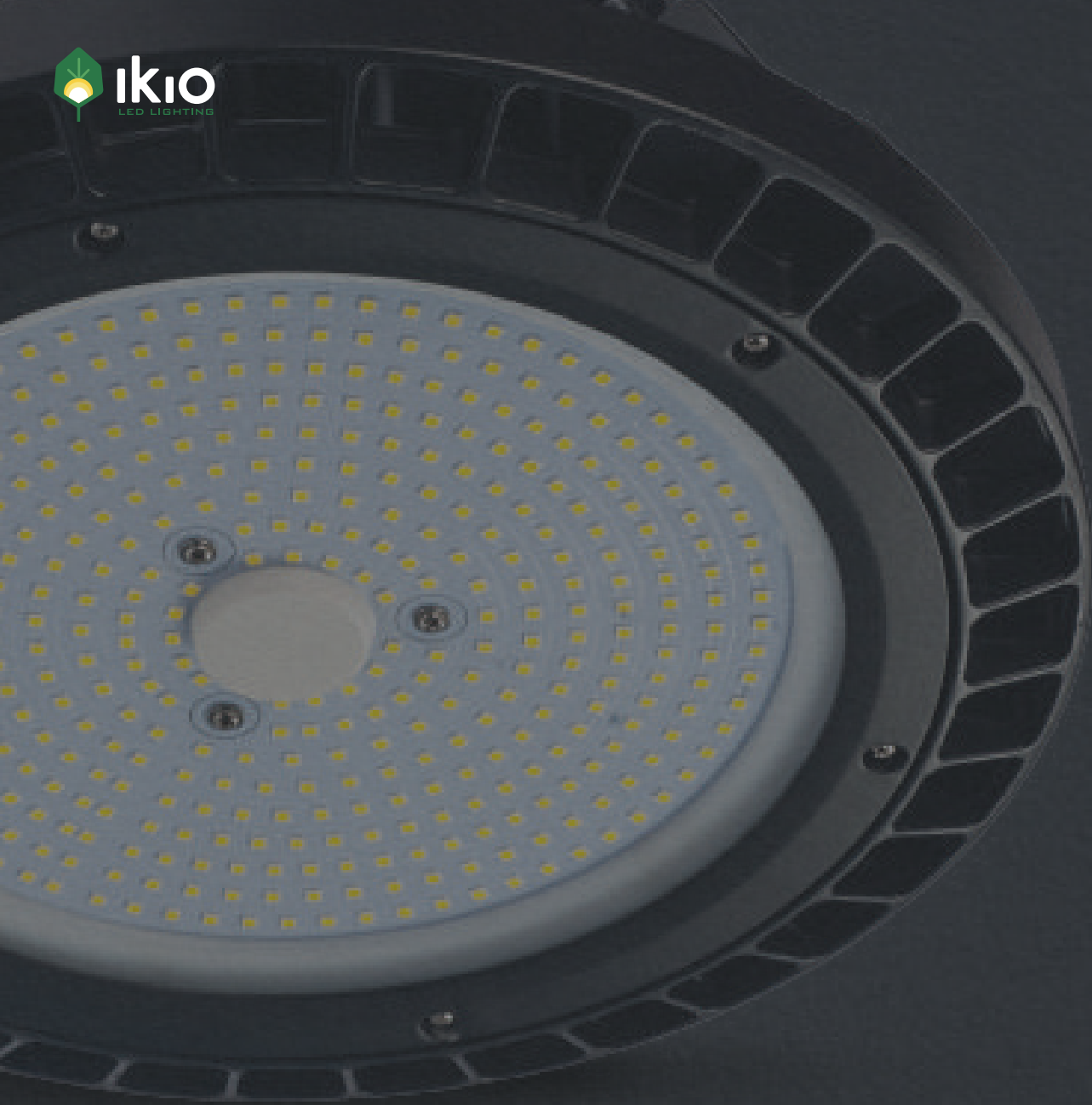

UFO High Bays

UFO high bays are named so because of their alien UFO like shape that we get to see in the sci-fi movies. These lights are especially recommended to replace the traditional metal halides. LED UFO high bays are an ideal choice to illuminate spaces with a ceiling height of more than 35 feet due to their high light output and wide beam rendering capability. The most common places of application for the UFO high bays are warehouses, industrial, retail, and construction spaces.

Our Offerings

We offer a range of LED luminaires under the UFO high bays.





Superia

UFO HIGH BAY

Electrical

Power	100 W 120 W 150 W 200 W
Voltage	100-277 V
Power Factor	0.937

Lighting Performance

Lumens	18000 lm 21600 lm 27000 lm 36000 lm
Efficacy	180 lm/W
Color Temperature (CCT)	3000 K 4000 K 5000 K 5700 K 6500 K
Color Rendering (CRI)	80+
Beam Angle	120°
Light Distribution	Type VS
Dimmable Lighting Control	0-10 V, Range 10% - 100%

Environment

Operating Temperature	-10 °F ~ +120 °F
Suitable Location	WET
Ingress Protection Rating (IP)	IP65

Lifespan

Average Life (Hours)	100,000
Warranty (Years)	10

Components

LED Light Source	Samsung
Driver	Lifud

Construction

Housing	Aluminum
Cover	Tempered Glass
Base / Power Supply	Hard Wire
Finish	Black
Diffuser	Clear

Application Areas

Ideal for retrofitting inefficient fixtures in malls, hospitals, airports, offices, lobbies and other residential and commercial applications.

Qualifications and Certifications

Qualified Part Number	IK-HBUF-L180
-----------------------	---------------------



DesignLights Consortium® (DLC) Premium qualified product. Not all versions of this product may be DLC qualified. Please check the DLC Qualified Products List at www.designlights.org/QPL to confirm which versions are qualified.

*Specifications, Warranty, and Qualifications can vary per item/SKU. See technical data sheets (TDS) for specific information.

Dimensions (Inches)

	100 W, 120 W	150 W, 200 W
Height	1.96"	2.16"
Diameter	Ø 10.23"	Ø 11.61"
Total Height	5.51"	5.98"

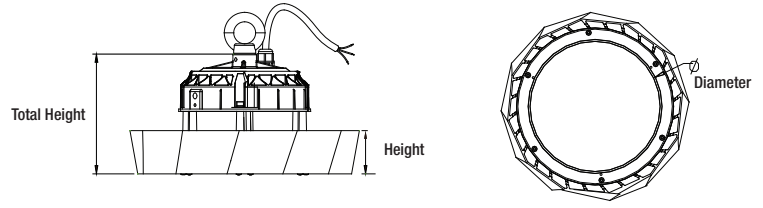

Installation Instructions

Important Safeguards

PLEASE FIND A QUALIFIED ELECTRICIAN FOR INSTALLATION. PLEASE READ THE INSTRUCTIONS BEFORE YOU INSTALL AND USE THE LUMINAIRE. WARNING, CAUTIONS AND OPERATING INSTRUCTIONS

- To reduce the risk of death, personal injury or property damage from fire, electric shock, falling parts, cuts/abrasions, and other hazards, read all warnings and instructions included with and on the fixture box and all fixture labels.
- Before installing, servicing, or performing routine maintenance upon this equipment, follow these general precautions.
- Commercial installation, service and maintenance of luminaires should be performed by a qualified licensed electrician.
- For the installation: If you are unsure about the installation or maintenance of the luminaires, consult a qualified licensed electrician and check your local electrical code.
- To prevent wiring damage or abrasion, do not expose wiring to edges of sheet metal or other sharp objects.
- Do not make or alter any open holes in an enclosure of wiring or electrical components during kit installation.

WARNING: RISK OF FIRE OR ELECTRICAL SHOCK

- Turn off electrical power at fuse or circuit breaker box before wiring fixture to the power supply.
- Turn off the power when you perform any maintenance.
- Verify that supply voltage is correct by comparing it with the luminaire label information.
- Make all electrical and grounded connections in accordance with the National Electrical Code and any applicable local code requirements.
- All wiring connections should be capped with UL approved wire connectors.
- Do not make or alter any open holes in an enclosure of wiring or electrical components during kit installation.

CAUTION: RISK OF INJURY

- Avoid direct eye exposure to the light source while it is on.
- Account for small parts and destroy packing material, as these may be hazardous to children.
- Mounting surface should be of sufficient strength to hold more than the weight of the fixture.
- Suitable for Wet locations

WARNING: DISCONNECT POWER BEFORE INSTALLING OR SERVICING.

General Wiring Diagram

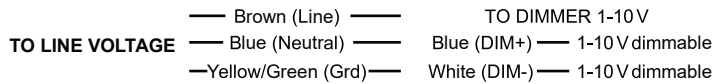

*CAP DIMMING WIRES SEPARATELY IF NOT USING THE DIMMING FUNCTION.

Hook Installation | 100 W / 120 W / 150 W / 200 W

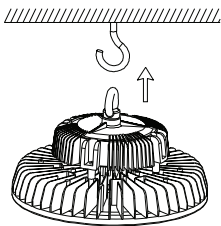

1. Drill a hole into the ceiling for the appropriate size hook (provided by installer).

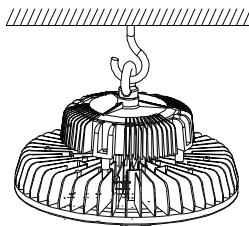

2. Secure hook to the ceiling and hang the fixture from the hook.

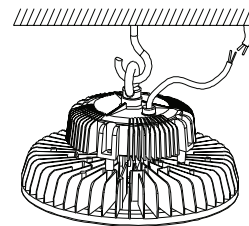

3. Connect the electrical cables; Brown-L, Blue-N, Yellow/Green-Ground. If using in wet locations, ensure all electrical connections and installation holes have a water tight seal.

Bracket Installation | Bracket sold separately

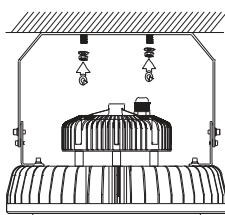

1. Attach the bracket to the mounting surface.

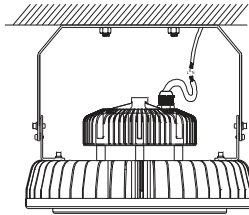

2. Connect the electrical cables. Brown-L, Blue-N, Yellow/Green-Ground. If using in wet locations, ensure all electrical connections and installation holes have a water tight seal.

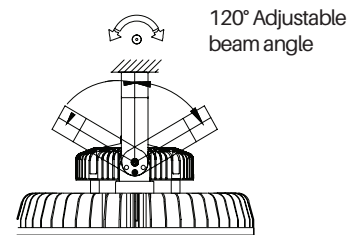

3. Adjust the bracket to the beam angle you need.



Rodella

UFO HIGH BAY

Electrical

Power	100 W 150 W 200 W 240 W
Voltage	100-277 V
Power Factor	0.9956

Lighting Performance

Lumens	14000 lm 21000 lm 28000 lm 33600 lm
Efficacy	140 lm/W
Color Temperature (CCT)	3500 K 4000 K 5000 K
Color Rendering (CRI)	70+
Beam Angle	120°
Light Distribution	Type VS
Dimmable Lighting Control	0-10 V, Range 10% - 100%

Environment

Operating Temperature	-10 °F ~ +120 °F
Suitable Location	WET
Ingress Protection Rating (IP)	IP65

Lifespan

Average Life (Hours)	100,000
Warranty (Years)	10

Components

LED Light Source	Lumiled 3030
Driver	Meanwell

Construction

Housing	Aluminum
Cover	Tempered Glass
Base / Power Supply	Hard Wired
Finish	Black
Diffuser	Clear

Application Areas

Ideal for retrofitting inefficient fixtures in malls, hospitals, airports, offices, lobbies and other residential and commercial applications.

Qualifications and Certifications

Qualified Part Number	IK-HBP2
-----------------------	----------------



DesignLights Consortium® (DLC) Premium qualified product. Not all versions of this product may be DLC qualified. Please check the DLC Qualified Products List at www.designlights.org/QPL to confirm which versions are qualified.

*Specifications, Warranty, and Qualifications can vary per item/SKU. See technical data sheets (TDS) for specific information.

Dimensions (Inches)

	100 W, 150 W	200 W	240 W
Length	N/A	N/A	N/A
Diameter	Ø11.6	Ø 11.85"	Ø 12.6"
Height	5.9"	6.4"	6.3"

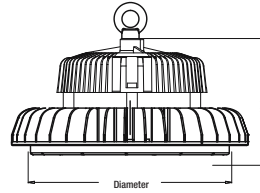

Installation Instructions

Important Safeguards

PLEASE FIND A QUALIFIED ELECTRICIAN FOR INSTALLATION. PLEASE READ THE INSTRUCTIONS BEFORE YOU INSTALL AND USE THE LUMINAIRE. WARNING, CAUTIONS AND OPERATING INSTRUCTIONS

- To reduce the risk of death, personal injury or property damage from fire, electric shock, falling parts, cuts/abrasions, and other hazards, read all warnings and instructions included with and on the fixture box and all fixture labels.
- Before installing, servicing, or performing routine maintenance upon this equipment, follow these general precautions.
- Commercial installation, service and maintenance of luminaires should be performed by a qualified licensed electrician.
- For the installation: If you are unsure about the installation or maintenance of the luminaires, consult a qualified licensed electrician and check your local electrical code.
- To prevent wiring damage or abrasion, do not expose wiring to edges of sheet metal or other sharp objects.
- Do not make or alter any open holes in an enclosure of wiring or electrical components during kit installation.

WARNING: RISK OF FIRE OR ELECTRICAL SHOCK

- Turn off electrical power at fuse or circuit breaker box before wiring fixture to the power supply.
- Turn off the power when you perform any maintenance.
- Verify that supply voltage is correct by comparing it with the luminaire label information.
- Make all electrical and grounded connections in accordance with the National Electrical Code and any applicable local code requirements.
- All wiring connections should be capped with UL approved wire connectors.
- Do not make or alter any open holes in an enclosure of wiring or electrical components during kit installation.

CAUTION: RISK OF INJURY

- Avoid direct eye exposure to the light source while it is on.
- Account for small parts and destroy packing material, as these may be hazardous to children.
- Mounting surface should be of sufficient strength to hold more than the weight of the fixture.
- Suitable for wet locations.

WARNING: DISCONNECT POWER BEFORE INSTALLING OR SERVICING.

General Wiring Diagram

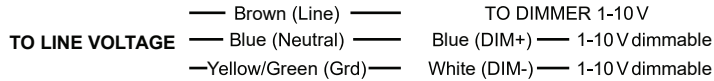

**CAP DIMMING WIRES SEPARATELY IF NOT USING THE DIMMING FUNCTION.*

Hook Installation | 100 W / 150 W / 200 W / 240 W

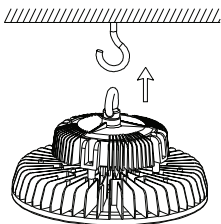

1. Drill a hole into the ceiling for the appropriate size hook (provided by installer).

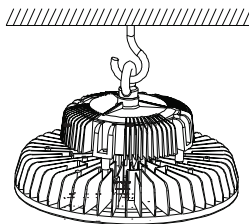

2. Secure hook to the ceiling and hang the fixture from the hook.

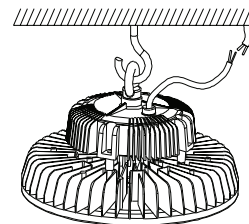

3. Connect the electrical cables; Brown-L, Blue-N, Yellow/Green-Ground. If using in wet locations, ensure all electrical connections and installation holes have a water tight seal.

Bracket Installation | Bracket sold separately

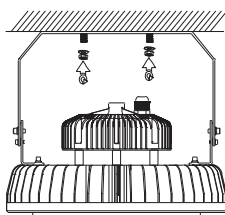

1. Attach the bracket to the mounting surface.

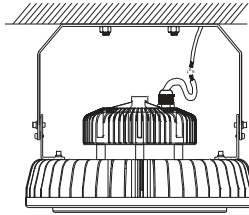

2. Connect the electrical cables. Brown-L, Blue-N, Yellow/Green-Ground. If using in wet locations, ensure all electrical connections and installation holes have a water tight seal.

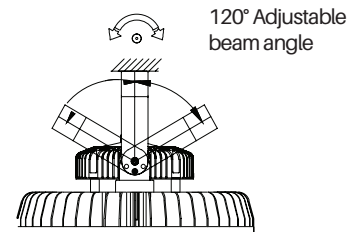

3. Adjust the bracket to the beam angle you need.



Halo

UFO HIGH BAY

Electrical

Power	100 W 150 W 200 W 240 W
Voltage	100-277 V (Also available in 277-480 V)
Power Factor	0.93

Lighting Performance

Lumens	17000 lm 25500 lm 34000 lm 40800 lm
Efficacy	170 lm/W
Color Temperature (CCT)	4000 K 5000 K
Color Rendering (CRI)	70+
Beam Angle	120°
Dimmable Lighting Control	0-10 V, Range 10% - 100%

Environment

Operating Temperature	-22 °F~ +122 °F
Suitable Location	WET
Ingress Protection Rating (IP)	IP65

Lifespan

Average Life (Hours)	50,000
Warranty (Years)	5

Components

LED Light Source	Lumiled
Driver	Lifud

Construction

Housing	Aluminum
Cover	Glass
Finish	Black

Application Areas

Sports Arenas, Airports, Warehouses, Gymnasiums, Courtyards Plazas, Public Areas.

*Specifications, Warranty, and Qualifications can vary per item/SKU. See technical data sheets (TDS) for specific information.

Dimensions (Inches)

Height	7.8"
Diameter	Ø 14.8"

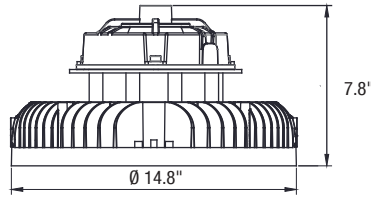

Installation Instructions

Important Safeguards

PLEASE FIND A QUALIFIED ELECTRICIAN FOR INSTALLATION. PLEASE READ THE INSTRUCTIONS BEFORE YOU INSTALL AND USE THE LUMINAIRE. WARNING, CAUTIONS AND OPERATING INSTRUCTIONS

- To reduce the risk of death, personal injury or property damage from fire, electric shock, falling parts, cuts/abrasions, and other hazards, read all warnings and instructions included with and on the fixture box and all fixture labels.
- Before installing, servicing, or performing routine maintenance upon this equipment, follow these general precautions.
- Commercial installation, service and maintenance of luminaires should be performed by a qualified licensed electrician.
- For the installation: If you are unsure about the installation or maintenance of the luminaires, consult a qualified licensed electrician and check your local electrical code.
- To prevent wiring damage or abrasion, do not expose wiring to edges of sheet metal or other sharp objects.
- Do not make or alter any open holes in an enclosure of wiring or electrical components during kit installation.

WARNING: RISK OF FIRE OR ELECTRICAL SHOCK

- Turn off electrical power at fuse or circuit breaker box before wiring fixture to the power supply.
- Turn off the power when you perform any maintenance.
- Verify that supply voltage is correct by comparing it with the luminaire label information.
- Make all electrical and grounded connections in accordance with the National Electrical Code and any applicable local code requirements.
- All wiring connections should be capped with UL approved wire connectors.
- Do not make or alter any open holes in an enclosure of wiring or electrical components during kit installation.

CAUTION: RISK OF INJURY

- Avoid direct eye exposure to the light source while it is on.
- Account for small parts and destroy packing material, as these may be hazardous to children.
- Mounting surface should be of sufficient strength to hold more than the weight of the fixture.
- Suitable for Wet locations

WARNING: DISCONNECT POWER BEFORE INSTALLING OR SERVICING.

General Wiring Diagram

AC cord

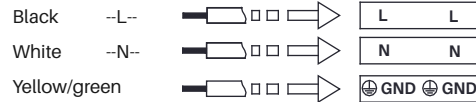

Label

0-10 V Dimmable

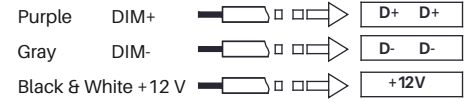

Installation

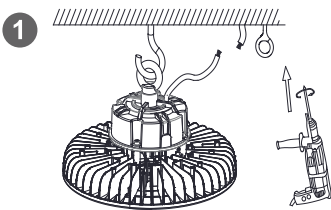

Drilling holes in the ceiling, and install the expansion screws and hook.

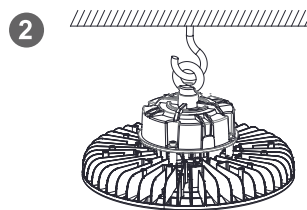

Hanging the fixture.

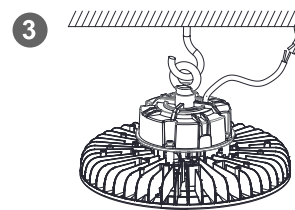

Connect the cables, Take care of the waterproof processing.

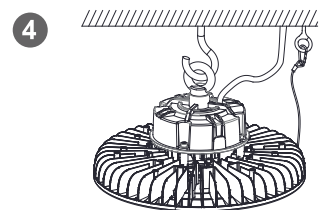

Install the safety rope and tighten the safety rope.

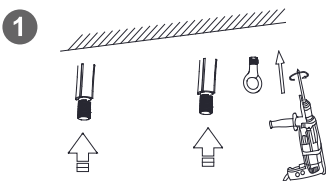

Drilling holes in the ceiling, and install the expansion screws.

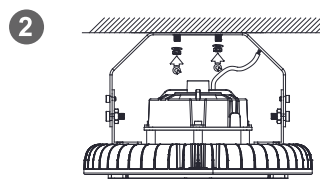

Fix the bracket.

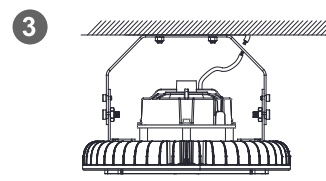

Connect the cables, Take care of the waterproof processing.

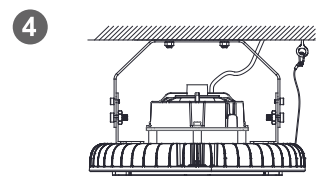

Install the safety rope and tighten the safety rope.



Halo pro

UFO HIGH BAY

Electrical

Power	300 W 400 W 500 W 600 W
Voltage	100-277 V (Also available in 277-480 V)
Power Factor	0.93

Lighting Performance

Lumens	51000 lm 68000 lm 85000 lm 102000 lm
Efficacy	170 lm/W
Color Temperature (CCT)	4000 K 5000 K
Color Rendering (CRI)	70+
Beam Angle	120°
Dimmable Lighting Control	0-10 V, Range 10% - 100%

Environment

Operating Temperature	-22 °F~ +122 °F
Suitable Location	WET
Ingress Protection Rating (IP)	IP65

Lifespan

Average Life (Hours)	50,000
Warranty (Years)	5

Components

LED Light Source	Lumiled
Driver	Lifud

Construction

Housing	Aluminum
Cover	Glass
Finish	Black

Application Areas

Sports Arenas, Airports, Warehouses, Gymnasiums, Courtyards Plazas, Public Areas.

*Specifications, Warranty, and Qualifications can vary per item/SKU. See technical data sheets (TDS) for specific information.

Dimensions (Inches)

Height	7.8"
Diameter	Ø 14.8"

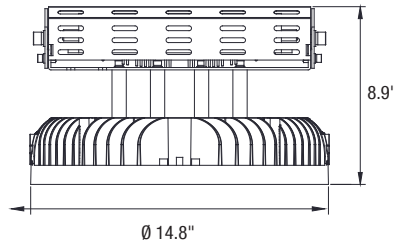

Installation Instructions

Important Safeguards

PLEASE FIND A QUALIFIED ELECTRICIAN FOR INSTALLATION. PLEASE READ THE INSTRUCTIONS BEFORE YOU INSTALL AND USE THE LUMINAIRE. WARNING, CAUTIONS AND OPERATING INSTRUCTIONS

- To reduce the risk of death, personal injury or property damage from fire, electric shock, falling parts, cuts/abrasions, and other hazards, read all warnings and instructions included with and on the fixture box and all fixture labels.
- Before installing, servicing, or performing routine maintenance upon this equipment, follow these general precautions.
- Commercial installation, service and maintenance of luminaires should be performed by a qualified licensed electrician.
- For the installation: If you are unsure about the installation or maintenance of the luminaires, consult a qualified licensed electrician and check your local electrical code.
- To prevent wiring damage or abrasion, do not expose wiring to edges of sheet metal or other sharp objects.
- Do not make or alter any open holes in an enclosure of wiring or electrical components during kit installation.

WARNING: RISK OF FIRE OR ELECTRICAL SHOCK

- Turn off electrical power at fuse or circuit breaker box before wiring fixture to the power supply.
- Turn off the power when you perform any maintenance.
- Verify that supply voltage is correct by comparing it with the luminaire label information.
- Make all electrical and grounded connections in accordance with the National Electrical Code and any applicable local code requirements.
- All wiring connections should be capped with UL approved wire connectors.
- Do not make or alter any open holes in an enclosure of wiring or electrical components during kit installation.

CAUTION: RISK OF INJURY

- Avoid direct eye exposure to the light source while it is on.
- Account for small parts and destroy packing material, as these may be hazardous to children.
- Mounting surface should be of sufficient strength to hold more than the weight of the fixture.
- Suitable for Wet locations

⚠ WARNING: DISCONNECT POWER BEFORE INSTALLING OR SERVICING.

General Wiring Diagram

AC cord

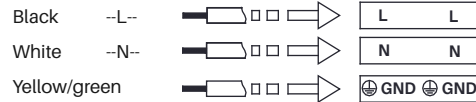

0-10 V Dimmable



Installation

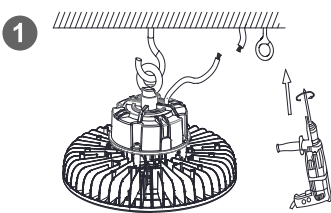

Drilling holes in the ceiling, and install the expansion screws and hook.

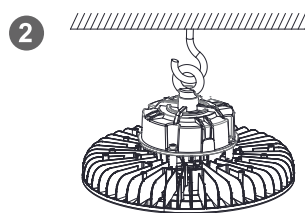

Hanging the fixture.

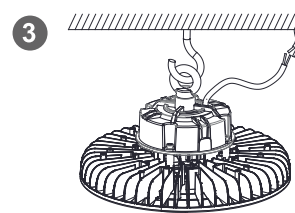

Connect the cables, Take care of the waterproof processing.

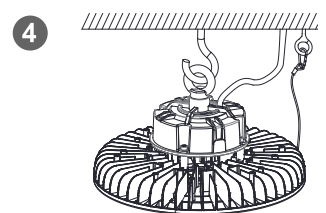

Install the safety rope and tighten the safety rope.

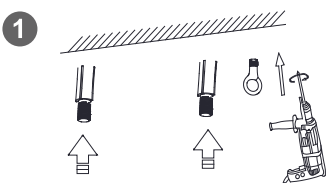

Drilling holes in the ceiling, and install the expansion screws.

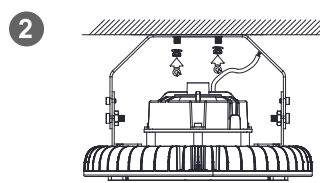

Fix the bracket.

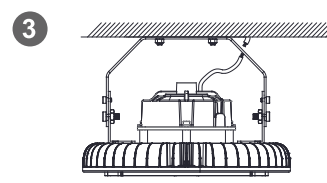

Connect the cables, Take care of the waterproof processing.

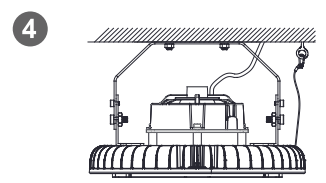

Install the safety rope and tighten the safety rope.



Scan To Explore Our
Exciting Product Range



ikio
LED LIGHTING

(1) 844-533-4546 | info@ikioledlighting.com
8470 Allison Pointe Blvd, Suite 128 Indianapolis, IN 46250
www.ikioledlighting.com